

# Nova Medium 62 Trackspot

## Installation / Maintenance Instructions

LIGHT FORMS

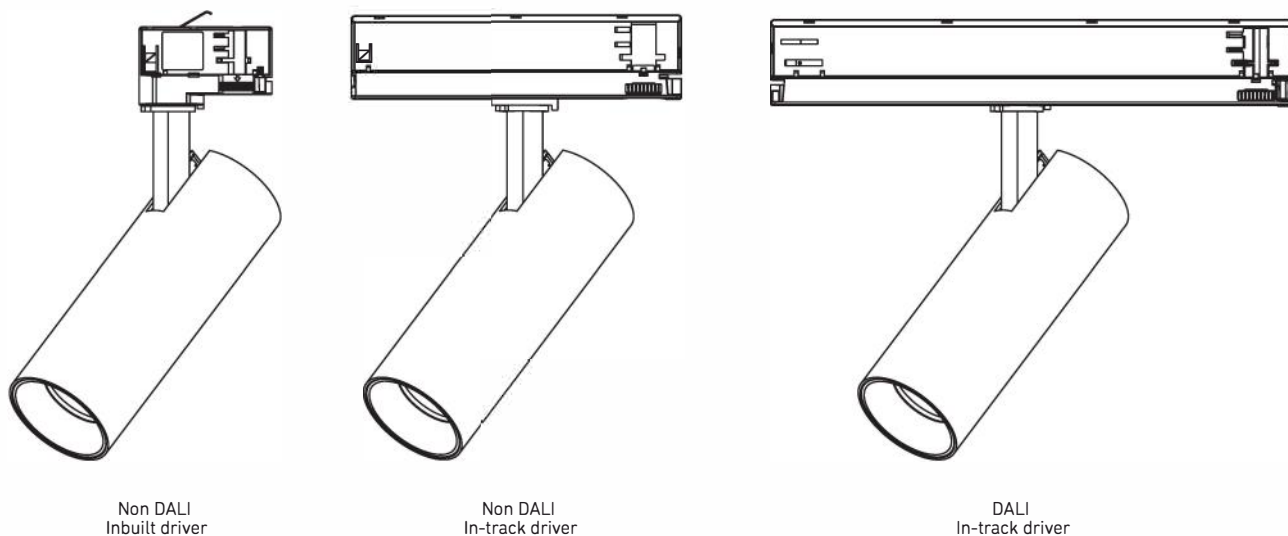

### NOV62-TS

#### Precautions and Warnings

- Read all instructions carefully, the safety of this product is only guaranteed if the instructions are followed, retain these instructions for future use.
- Turn off the power supplier before installation and maintenance.
- Installation must be carried out by a trained professional in accordance with all National electrical codes and regulations.
- To avoid the risk of fire and overheating, make sure all connection, including those made by others, are correct and secure.
- Do not pinch or apply excessive tension on the electrical wires. Damage due to improper handling and installation will void the warranty.
- If there is any damage to the product or the cable, the product must be returned to the retailer or manufacturer.

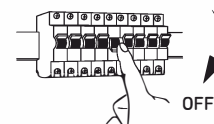

#### Luminaire Details

Power Supply:	230V AC 50Hz
IP Rating:	IP20
Class:	⊕
Ta Max:	45°C

Fixing Method:	Track adaptor
Diameter:	62mm
Length:	170mm

Light Forms  
UK Head Office

LightForms.com

8 Richfield Avenue  
Reading  
RG1 8EQ

T +44 (0)20 8571 3785  
E London@  
LightForms.com

# Nova Small 62 Trackspot

## Installation / Maintenance Instructions

**LIGHT FORMS**

**1**

Release locking tab.

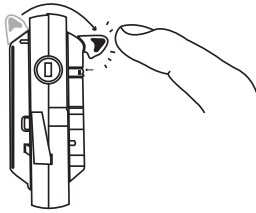

In built driver

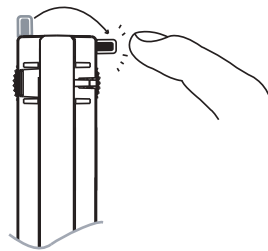

In-Track driver

**4**

Select the electrical circuit

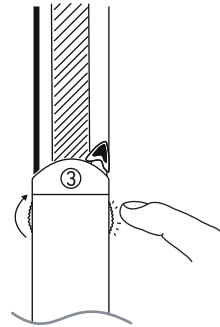

In built driver

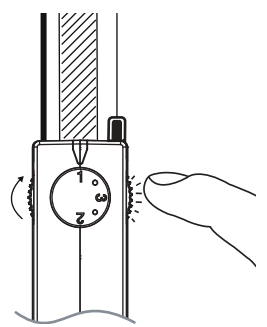

In-Track driver

**2**

Insert into track. Note the orientation and guide pins.

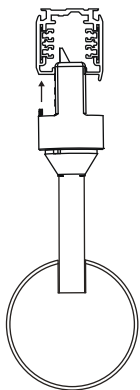

In built driver

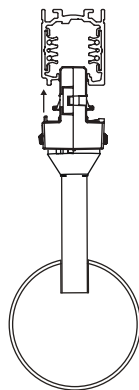

In-Track driver

**5**

Adjust.

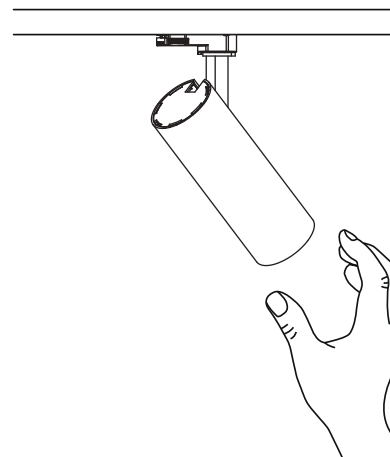

**3**

Lock the fixture to the track.

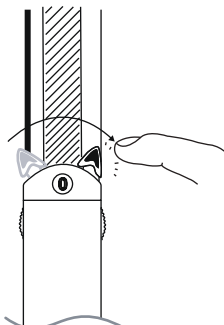

In built driver

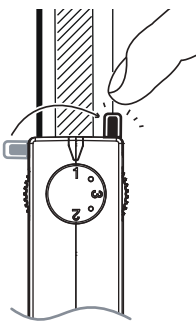

In-Track driver

**6**

Turn on power.

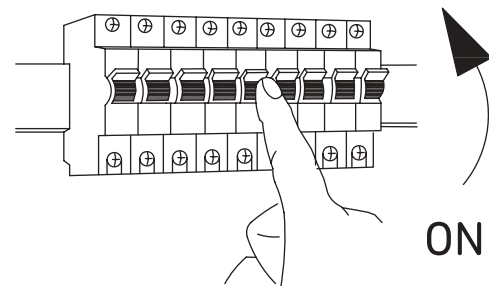

Light Forms  
UK Head Office

LightForms.com

8 Richfield Avenue  
Reading  
RG1 8EQ

T +44 (0)20 8571 3785  
E London@  
LightForms.com

Registered in England & Wales  
No. 6750892

ISO 9001 Quality Management  
ISO 14001 Environmental Management  
ISO 45001 Occupational Health & Safety Management