

LIGHTPLANE 1H - LP1H

Indirect / Direct

Suspended

Wall

Surface (direct only)

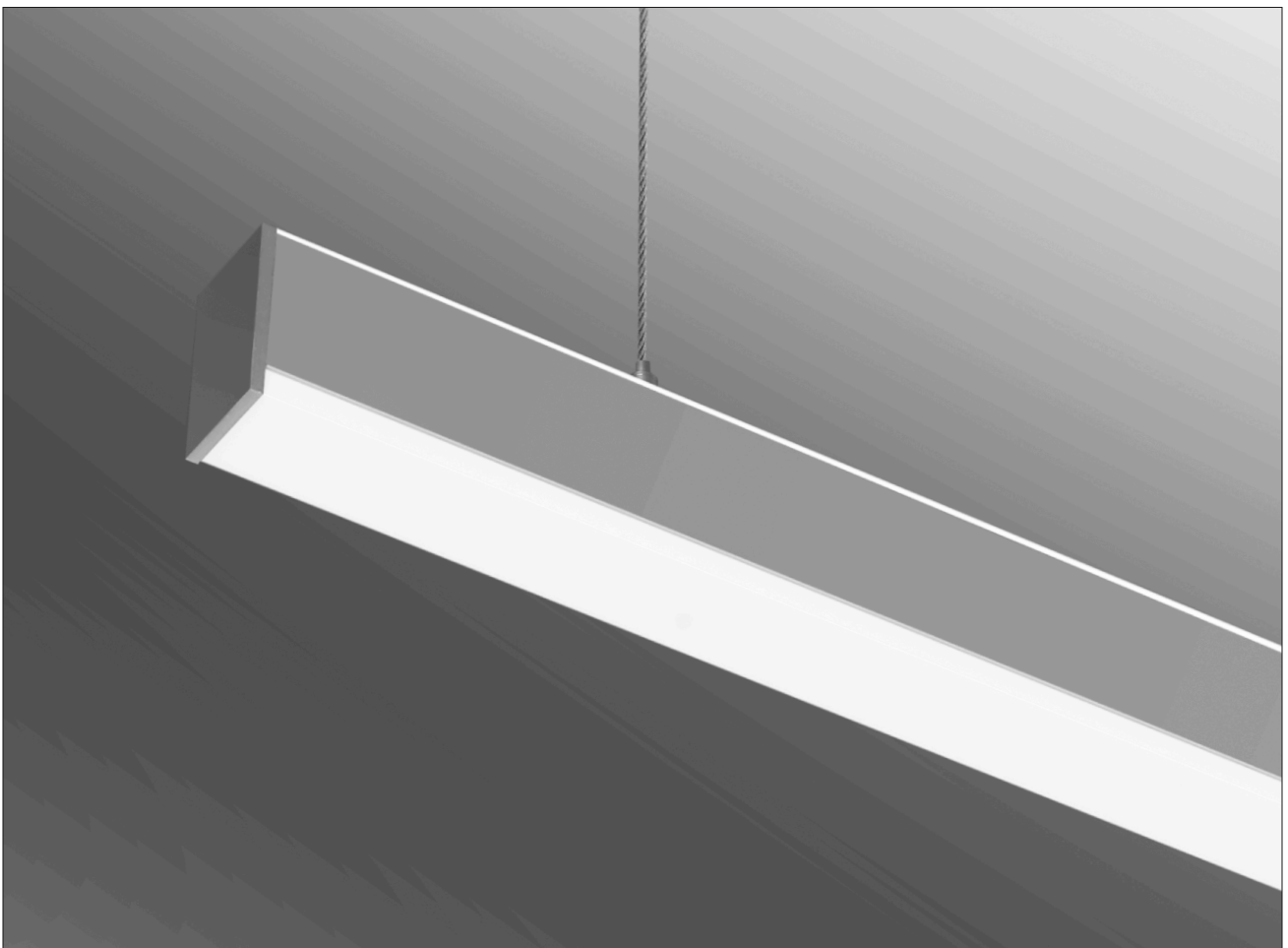

LIGHTPLANE 1H — LP1H

Suspended, Wall, (Indirect / Direct) - Surface (Direct only)

LIGHT FORMS

1. Base Model

LP1HSID
LP1HWID
LP1HSM

Suspended - Indirect/Direct
Wall Mounted - Indirect/Direct
Surface Mounted (Direct only - snap clip - see below)

Snap Clip facilitates an easily removable and replaceable surface mounted fitting.

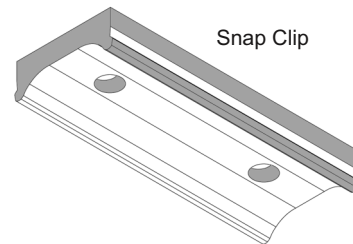

2. Run Length/Size

Enter length in mm for custom lengths.
See **Standard Lengths and Shapes** PDF for standard products.

3. LED Lamping (indirect uplight)

(data quoted for Flat Lens)

INDMED - **xxxxK**

INDCV - **xxxxK**

INDSTD - TW

INDHI - TW

INDSTD - RGBW - **xxxxK**

INDHI - RGBW - **xxxxK**

4. LED Lamping (direct downlight)

(data quoted for Drop Lens)

MED - **xxxxK**

CV - **xxxxK**

STD - TW

HI - TW

STD - RGBW - **xxxxK**

HI - RGBW - **xxxxK**

LIGHTPLANE 1H — LP1H

Suspended, Wall, (Indirect / Direct) - Surface (Direct only)

**LIGHT
FORMS**

5. LED Driver (remote only)

1-10V	1-10V dimming
DALI	DALI dimming
DMX	DMX dimming
NONDIM	Non-dimmable
OTHER	(Consult factory for options)

6. Lens

CV / FLAT	Aluminium Cover on top / FLAT Lens for downlight
CV / DROP	Aluminium Cover on top / DROP Lens for downlight
FLAT / FLAT	FLAT lens for uplight / FLAT lens for downlight
FLAT / DROP	FLAT lens for uplight / DROP lens for downlight
DROP / DROP	DROP lens for uplight / DROP lens for downlight



Choose CV / FLAT or CV / DROP with LP1HSM (surface mounted).

7. Finish

AL	Standard, natural aluminium
BK	Black powdercoat
WH	White powdercoat
RAL/ ___	Specify RAL powdercoat (ex: #RAL/3003)
BRONZE	Bronze powdercoat

8. Canopy

NC	No canopy (for Wall or Surface mounted)
STD	Standard canopy & separate suspension
COMBO	Combo suspension canopy
SMALL	Small canopy & separate suspension

9. Additional options

EM	3 hour Emergency Kit - remote
DALIEM	3 hour DALI Emergency Driver/Battery - remote
DALIEMPRO	3 hour DALI EMPRO Emergency Driver/Battery - remote
PIR-A	PIR Absence Detector - remote
PIR-P	PIR Presence Detector - remote
DALIPIR	DALI PIR Sensor - remote
OTHER	Contact Factory

LIGHTPLANE 1H — LP1H

Suspended, Wall, (Indirect / Direct) - Surface (Direct only)



Dimensions

FLAT/FLAT LENS

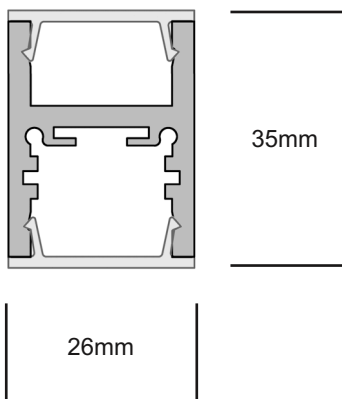

FLAT/DROP LENS

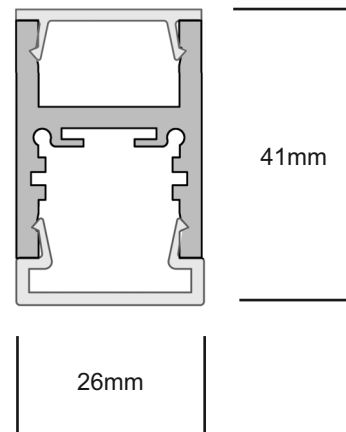

DROP/DROP LENS

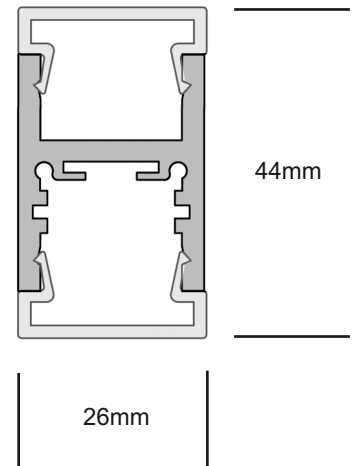

Mounting Options

LP1HSID
Suspended Indirect/Direct

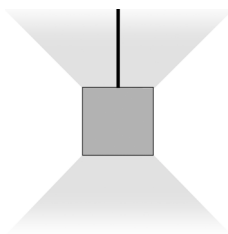

LP1HWID
Wall Mount Indirect/Direct

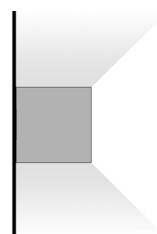

LP1HSM
Surface Mount Direct

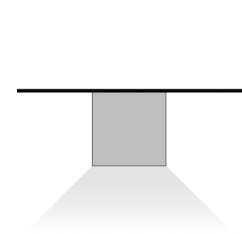

LIGHTPLANE 1H — LP1H

Suspended, Wall, (Indirect / Direct) - Surface (Direct only)

LIGHT FORMS

Housing

100% recyclable, extruded architectural grade T6061 aluminium

Emergency

Luminaires can be wired for emergency circuit and/or emergency battery backup. Consult factory for options.

Suspension Hardware

STD	Standard separate 115mm diameter power canopy and suspension
COMBO	115mm diameter canopy and suspension are combined
SMALL	82mm diameter small separate power canopy and suspension

Options

Mitered Corners
Consult factory for mitered corner angle options.

Finish

Standard finish is "Ultimatte" aluminium - a smooth, clean and durable finish achieved from a deep-etch and two step clear anodizing process. White, Black, Bronze or custom RAL powdercoat options are also available.



WH - WHITE

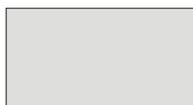

AL - ALUMINIUM



RAL/___

Default canopy finish is to match fitting color, unless otherwise specified



BK - BLACK



BRONZE



STD



Combo



Small

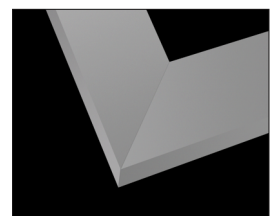

Mitered Corners

LIGHT FORMS - CONFIGURATION SHEET - REV 5

Light Forms

Architectural Lighting
www.lightforms.com

Registered in England
No. 6750892

Registered Address
Unit 7C Boeing Way
International Trading Centre
Middlesex, UB2 5LB

UK

Unit 7C Boeing Way
International Trading Estate
Middlesex
UB2 5LB

T +44 (0)20 8571 3785
F +44 (0)20 8090 3755
E ask@lightforms.com

India

353/2 Dr Hira Singh Road
Civil Lines
Ludhiana 141001
Punjab, India

T +91 98 7280 0488
E ajay@lightforms.com

China

Unit 3, Building A
No. 9 Phoenix Road
Torch Development Area
Zhongshan City
Guangdong China 528437

T +86 760 899 370 38
F +86 760 899 370 39
E ckirin@lightforms.com