

Micro H Beam – MICRO-HB

LED – 18 mm x 90 mm

FEATURES

Recessed Lens Fitting

Individual Fixture,
Continuous Run or
Configured Shape

Direct/Indirect,
Indirect or Direct
Distribution

Up to 8384 LM/M
and 102 LM/W

Two Standard
Output Options

RGB+W Option

Remote DALI, DMX,
10V or Phase Driver

Dimming Down to 0%

Remote Sensor
Options

Aluminium, White,
Black, Bronze or
Custom RAL Finish

OSRAM

LED Drivers &
Light Engines
Included

*Exceptions
may apply.
Enquire for
more details.*

SUSPENDED

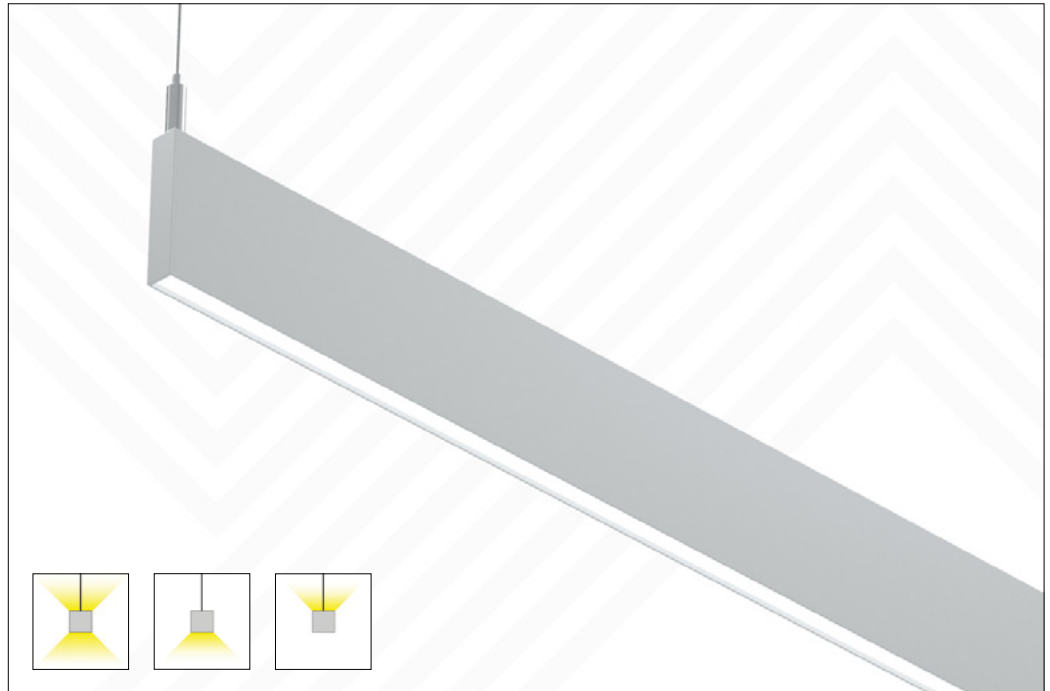

WALL / SURFACE

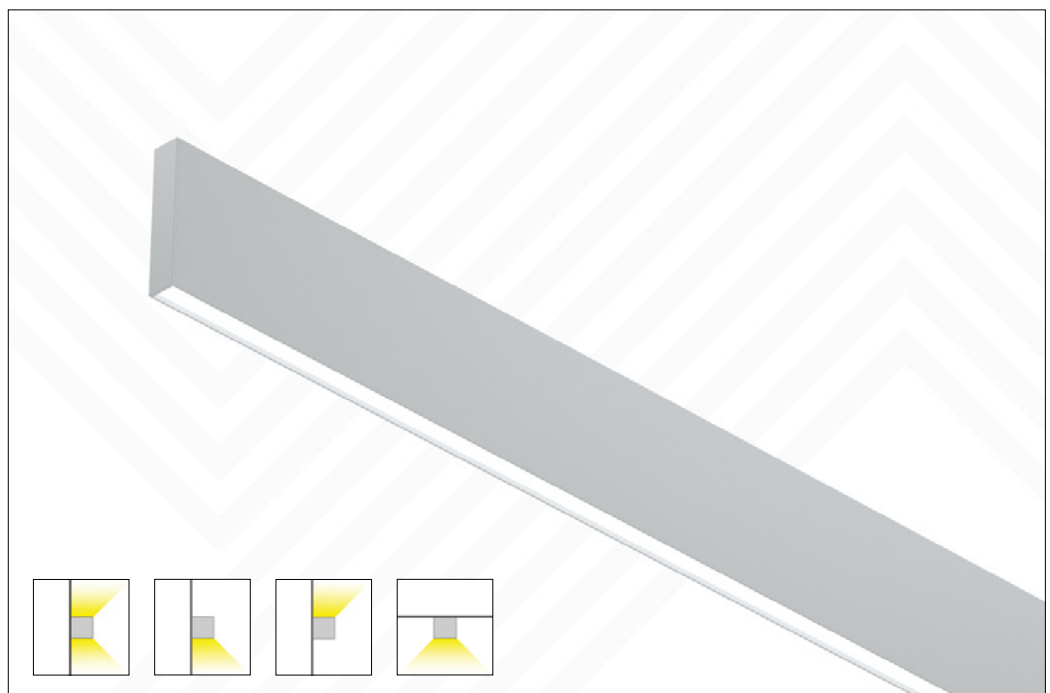

INSTRUCTIONS

Digital users: Check selection boxes and fill in fields directly in fillable, interactive PDF, save file, submit to Light Forms.

Manual users: Check selection boxes and fill in fields with pen, scan and save ALL pages as PDF document, submit to Light Forms.

1. BASE MODEL / MOUNTING Select ONE

- MICRO-HBS** Suspended
- MICRO-HBW** Wall
- MICRO-HBSM** Surface-Mount (direct only)

2. SIZE* Select ONE (linear or shape) and enter required length(s) in metres, ex: STR/20.5, US/9/7/6.5

INDIVIDUAL OR CONTINUOUS RUN

LINEAR

STR Straight

LENGTH A

CONFIGURATION

SHAPE*

- SQ** Square
- REC** Rectangle
- LL** L - Left
- LR** L - Right
- CX** Cross
- TEE** T - Shape
- US** U - Shape
- ZL** Zed - Left
- ZR** Zed - Right

LENGTH A

LENGTH B

LENGTH C



Straight
STR



Square
SQ



Rectangle
SQ



L - Left
LL



L - Right
LR

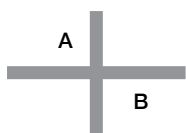

Cross
CX

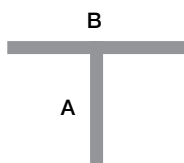

T - Shape
TEE



U - Shape
US

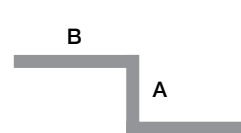

Zed - Left
ZL

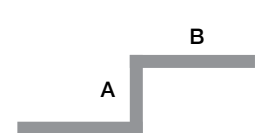

Zed - Right
ZL

*All Shapes are manufactured with 45° angled cuts to form 90° angle joints *except* CX and TEE which are made and joined using complete, uncut fixtures. Contact Light Forms for additional, custom shape configurations, ex: triangles, octagons, etc.

3. DIRECT LINEAR LAMPING & LENS Select NONE or ONE from each category (note exceptions below)

NONE Select when specifying an INDIRECT-ONLY fixture

<u>OUTPUT</u>	<u>CRI</u>	<u>CCT</u>	<u>LENS</u>	
LOW	80	2700K	DIFF	Diffuse
MED	90	3000K		
RGBW [^]		3500K		
		4000K		
		5000K		
		6500K		

**For RGBW, CRI does not apply (leave unchecked) and select 3000K or 4000K CCT only. White LEDs can remain uncommissioned for RGB-only output.*

4. INDIRECT LINEAR LAMPING & LENS Select NONE or ONE from each category (note exceptions below)

NONE Select when specifying an DIRECT-ONLY fixture; indirect not available for surface mount

<u>OUTPUT</u>	<u>CRI</u>	<u>CCT</u>	<u>LENS</u>	
LOW	80	2700K	DIFF/F	Diffuse
MED	90	3000K		
RGBW [^]		3500K		
		4000K		
		5000K		
		6500K		

**For RGBW, CRI does not apply (leave unchecked) and select 3000K or 4000K CCT only. White LEDs can remain uncommissioned for RGB-only output.*

5. INTEGRAL DRIVER* Select ONE

NONDIM	Non-dimming
DALI#	DALI driver, dimming down to 1%
1/10V	1-10V, dimming down to 1%
0/10V	0-10V, dimming down to 0%
DMX[^]	DMX driver, dimming down to 1%
PHASE	For use with phase-cut triac, IGBT or sine wave dimmer switches

**Driver selection applies to direct, indirect and/or downlight spots. Contact Light Forms if separate driver types for each are required.*

[^]DMX (or DALI) is required for use with RGBW

Micro H Beam

MICRO-HB | Suspended, Wall, Surface

**LIGHT
FORMS**

6. FINISH* Select ONE

AL	Anodised aluminium (standard)
WH	White powdercoat
BLK	Black powdercoat
BZ	Metallic bronze powdercoat
RAL/ _ _ _ _	Custom RAL# colour powdercoat, ex: RAL/3000

*Contact factory for additional finish options including Interpon, Farrow & Ball and silver and gold plating

See RAL colour options and codes at lightforms.com/RAL

7. POWERFEED COLOUR Select ONE

GP	Grey (standard for suspended, default for other mountings)
WP	White
BP	Black
TP	Transparent
XP	Custom colour (contact Light Forms for options)

8. CANOPY Select ONE

NONE	Select NONE when specifying wall or surface mount
STD	115mm canopy for each separate powerfeed and suspension point (standard)
SMALL	82mm canopy for each separate powerfeed and suspension point
COMBO	115mm combo canopy for locations with both a powerfeed and suspension point

9. OPTIONAL ADD-ONS Select as many as apply

A. EMERGENCY

EM	Remote, 3-hour emergency battery, manual testing
EM/DALI	Remote, 3-hour emergency battery with DALI interface, automatic testing
EC	Emergency circuit

B. SENSOR

PRES	Remote, PIR presence detector
DALI/PRES	Remote, DALI-compatible PIR presence detector
PHOTO	Remote, photocell/daylight detector

C. WIRELESS CONTROL

OLP*	Remote, Osram Lightify Pro wireless control module
-------------	--

*Must choose DALI option in DRIVER section.

Micro H Beam

MICRO-HB | Suspended, Wall, Surface

**LIGHT
FORMS**

DIMENSIONS

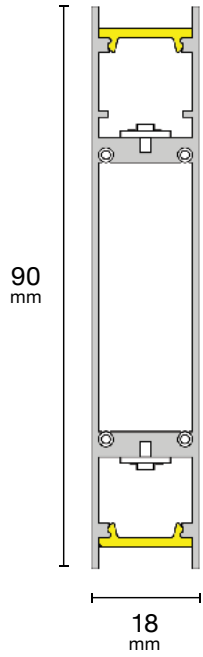

DISTRIBUTION

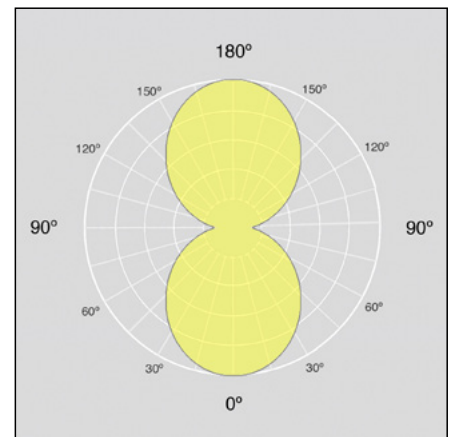
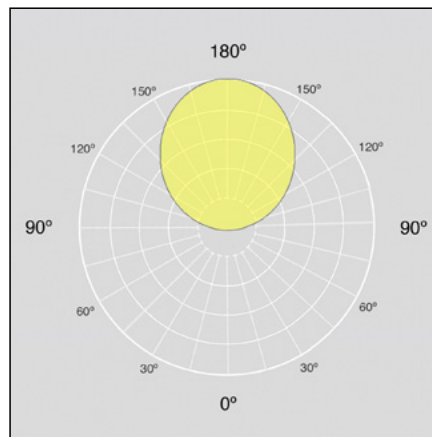
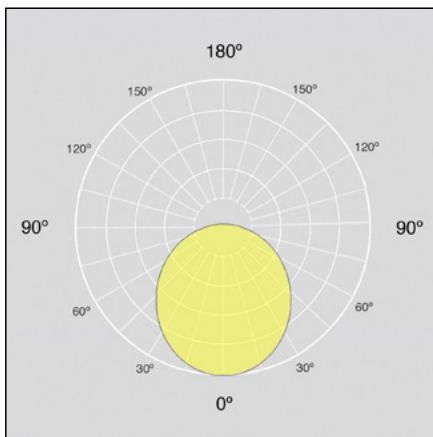

DIRECT LINEAR LAMPING – OPTIONS & PERFORMANCE DATA*

OUTPUT OPTIONS	DELIVERED LUMENS* LM/M	WATTS* W/M	EFFICACY* LM/W	CRI OPTIONS	CCT OPTIONS	LENS OPTIONS
LOW #	384	14.4	27	80 90	2700K 3000K 3500K 4000K 5000K 6500K	DIFF
MED #	550	15.4	36			
RGBW	Colour-Changing RGB+White N/A (entire system) 118 (white only)	19.2 (entire system) 9 (white only)	N/A (entire system) 13 (white only)	N/A (entire system) 80 (white only)	3000K 4000K	

L80 > 50,000 hours

Luminous flux +/- 5%

*Data provided is for the direct channel. Add and divide output numbers as necessary from both direct and indirect charts to calculate direct/indirect performance values.

#Performance data is based on a connected-load photometric test of MED output with 80 CRI at 4000K using a DALI driver and DIFF lens. Data values for all other outputs are extrapolations.

LENS OPTIONS

DIFF is a white satin, flush diffuser lens that produces smooth, even light across the lens surface.



Diffuse
DIFF

INDIRECT LINEAR LAMPING – OPTIONS & PERFORMANCE DATA*

OUTPUT OPTIONS	DELIVERED LUMENS* LM/M	WATTS* W/M	EFFICACY* LM/W	CRI OPTIONS	CCT OPTIONS	LENS OPTIONS
LOW[#]	336	14.4	23	80 90	2700K 3000K 3500K 4000K 5000K 6500K	DIFF
MED[#]	480	15.4	31			
RGBW	Colour-Changing RGB+White N/A (entire system) 103 (white only)	19.2 (entire system) 9 (white only)	N/A (entire system) 11 (white only)	N/A (entire system) 80 (white only)	3000K 4000K	

L80 > 50,000 hours

Luminous flux +/- 5%

**Data provided is for the indirect channel. Add and divide output numbers as necessary from both direct and indirect charts to calculate direct/indirect performance values.*

[#]Performance data is based on a connected-load photometric test of MED output with 80 CRI at 4000K using a DALI driver and DIFF lens. Data values for all other outputs are extrapolations.

LENS OPTIONS

DIFF is a white satin, flush diffuser lens that produces smooth, even light across the lens surface.



Diffuse
DIFF

Micro H Beam

MICRO-HB | Suspended, Wall, Surface

**LIGHT
FORMS**

SPECIFICATION DETAILS

HOUSING

100% recyclable, extruded architectural grade aluminium with minimum 2mm thickness.

FINISH OPTIONS

Standard finish is "Ultimatte" aluminium - a smooth, clean and durable finish achieved from a deep etch, two-step clear anodising process. White, Black, Bronze or custom RAL powdercoat options are also specifiable. Contact Light Forms for other finish options (Interpon, Farrow & Ball and silver and gold plating).



Aluminium
AL



White
WH



Black
BLK

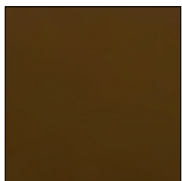

Bronze
BZ



Custom RAL
RAL

View all RAL colour options at: <https://lightforms.com/RAL>

SUSPENSION MOUNT CANOPY OPTIONS

Standard (STD) comprises separate 115 mm powerfeed canopy and cable bullet at powerfeed locations. SMALL comprises separate 85 mm powerfeed canopy and cable bullet at powerfeed locations. COMBO comprises combined 115mm canopy (canopy and cable bullet) at powerfeed locations. All options include cable bullets for non-powerfeed locations.

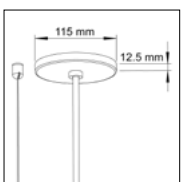

Standard
STD

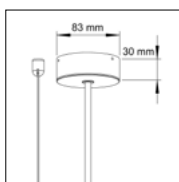

Small
SMALL

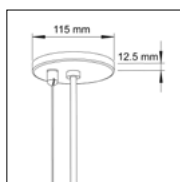

Combo
COMBO

REMOTE SENSORS

Optional, presence (PRES), DALI-compatible PIR presence (DALI/PRES) and daylight harvesting (PHOTO) sensors available. Contact Light Forms for further information.

WEIGHT

Approximately 1932 grams per linear metre. Weight may vary depending on mounting and other options.

OPERATING TEMPERATURE

Luminaire **MUST** be installed and operated **ONLY** in dry or damp environments where the ambient temperature ranges from -20°C to 50°C. Luminaire operation in environments outside this temperature range voids the warranty **AND** may damage the product or adversely impact lamp life, lumen output and colour consistency.

WARRANTY

5-year limited warranty. Details: lightforms.com/warranty

MANUFACTURING & CERTIFICATION

Products are manufactured in and comply with the health, safety and environmental protection standards of the respective region in which they are sold as indicated below.



Europe



Asia



Greater India
+ Middle East

Micro H Beam

MICRO-HB | Suspended, Wall, Surface

**LIGHT
FORMS**

PHOTOS

