

Serpentine 60 – SPT60

LED – 62 x 73 mm

FEATURES

Individual Fixture,
Continuous Run or
Custom Configuration

Direct/Indirect,
Direct or Indirect
Distribution

Up to 6044 lm/M and
117 lm/W

Four Standard Output
Options

Tunable White and
RGB+W Options

Integral DALI, DMX,
10V or Phase Driver

Dimming Down to 0%

Integral Downlight
Spot Options

Integral Sensor
Options

White, Black, Bronze
or Custom RAL Finish

**Custom shapes
available, contact
factory**

OSRAM

LED Drivers &
Light Engines
Included

*Exceptions
may apply.
Enquire for
more details.*

SUSPENDED

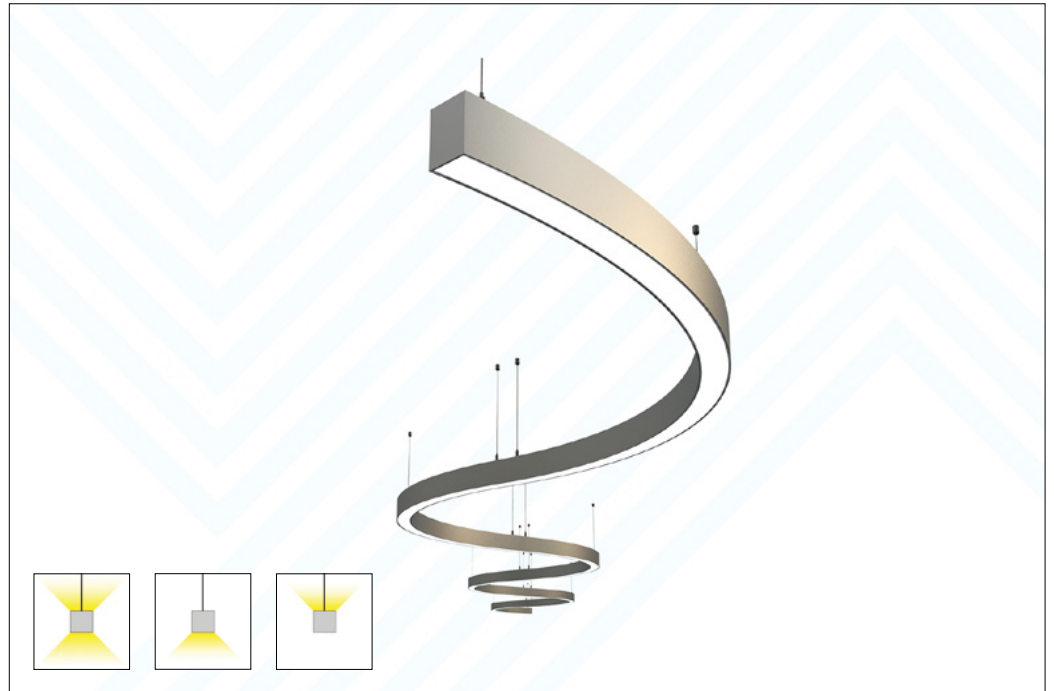

SURFACE



Serpentine 60

SPT60 | Suspended, Surface

**LIGHT
FORMS**

INSTRUCTIONS

Digital users: Check selection boxes and fill in fields directly in fillable, interactive PDF, save file, submit to Light Forms.

Manual users: Check selection boxes and fill in fields with pen, scan and save ALL pages as PDF document, submit to Light Forms.

1. BASE MODEL / MOUNTING Select ONE

SPT60S Suspended Surface
SPT60SM (direct only)

2. SIZE* Select length / radius and enter required quantity

STRAIGHT SECTIONS

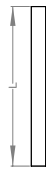

<u>L</u>	<u>QTY</u>	<u>L</u>	<u>QTY</u>	<u>L</u>	<u>QTY</u>
141		913		1683	
212		983		1754	
281		1054		1824	
352		1122		1895	
422		1193		1964	
493		1263		2035	
561		1334		2105	
632		1403		2176	
702		1474		2244	
773		1544		2315	
842		1615		2385	

1/8 CIRCLE

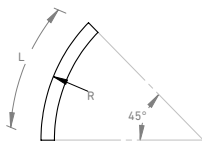

<u>R</u>	<u>L</u>	<u>QTY</u>	<u>R</u>	<u>L</u>	<u>QTY</u>	<u>R</u>	<u>L</u>	<u>QTY</u>
R300	239		R1300	1010		R2275	1784	
R400	309		R1375	1081		R2350	1854	
R475	377		R1450	1151		R2450	1924	
R575	477		R1550	1222		R2550	1994	
R650	518		R1650	1291		R2625	2065	
R750	588		R1750	1363		R2700	2135	
R825	659		R1825	1432		R2800	2205	
R925	729		R1900	1503		R2900	2275	
R1000	800		R2000	1572		R3000	2346	
R1100	870		R2100	1643		R3075	2416	
R1200	940		R2175	1713				

*All sizes shown are in millimetres.

Serpentine 60

SPT60 | Suspended, Surface

**LIGHT
FORMS**

INSTRUCTIONS

Digital users: Check selection boxes and fill in fields directly in fillable, interactive PDF, save file, submit to Light Forms.

Manual users: Check selection boxes and fill in fields with pen, scan and save ALL pages as PDF document, submit to Light Forms.

1/4 CIRCLE

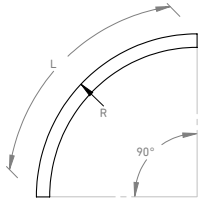

R	L	QTY	R	L	QTY	R	L	QTY
R300	478		R825	1318		R1375	2161	
R400	619		R925	1458		R1450	2301	
R475	754		R1000	1599		R1550	2444	
R575	894		R1100	1739		R1650	2582	
R650	1035		R1200	1800				
R750	1175		R1300	2020				

1/2 CIRCLE

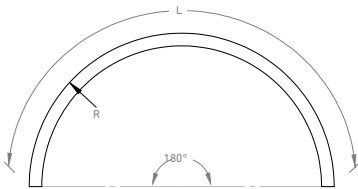

R	L	QTY	R	L	QTY	R	L	QTY
R300	955		R650	2070		R1000	3198	
R400	1238		R750	2350		R1100	3478	
R475	1508		R825	2636		R1200	3760	
R575	1788		R925	2915				

CROSSING

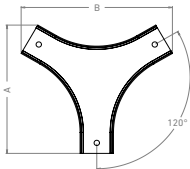

A	B	QTY
243	281	

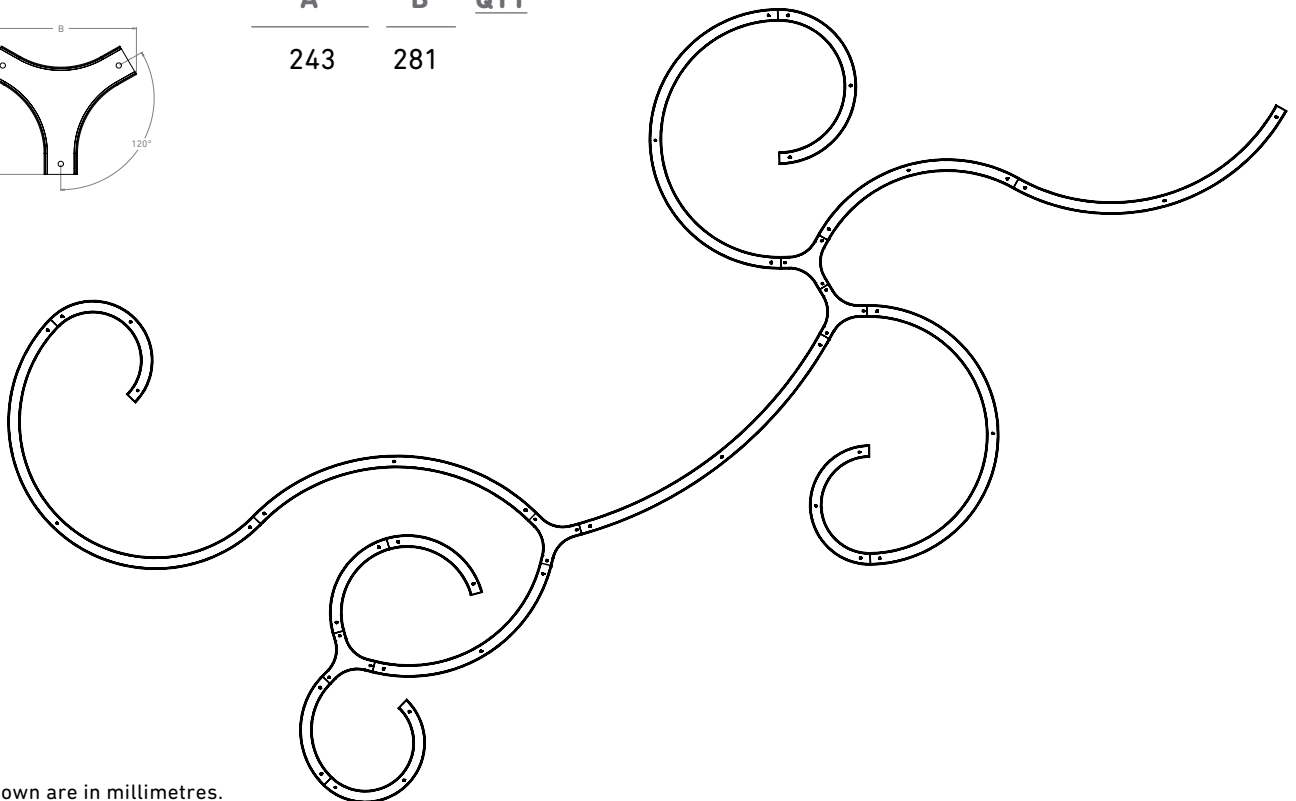

*All sizes shown are in millimetres.

3. DIRECT LINEAR LAMPING & LENS Select NONE or ONE from each category (note exceptions below)

NONE		Select when specifying an INDIRECT-ONLY fixture		
OUTPUT	CRI	CCT	LENS	
MIN	80	2700K	DIFF	Diffuse (std.)
LOW MED [#]	90	3000K	PRS	Clear
TUNE/LOW*		4000K		Prismatic
TUNE/MED*		5000K		
RGBW [^]		6500K		

[#]UGR19 is a low glare, UGR<19 optics package with low output and prismatic lens. LENS does not apply (leave unchecked).

*For TUNE/LOW and TUNE/MED, CRI and CCT do not apply (leave unchecked).

[^]For RGBW, CRI does not apply (leave unchecked) and select 3000K or 4000K CCT only. White LEDs can remain uncommissioned for RGB-only output.

4. INDIRECT LINEAR LAMPING & LENS Select NONE or ONE from each category (note exceptions below)

NONE		Select when specifying a DIRECT-ONLY fixture; indirect not available for surface mount		
OUTPUT	CRI	CCT	LENS	
MIN	80	2700K	DIFF	Diffuse (std.)
LOW MED [#]	90	3000K	PRS	Clear Prismatic
TUNE/LOW*		3500K		
TUNE/MED*		4000K		
RGBW [^]		5000K		
		6500K		

*For TUNE/LOW and TUNE/MED, CRI and CCT do not apply (leave unchecked).

[^]For RGBW, CRI does not apply (leave unchecked) and select 3000K or 4000K CCT only. White LEDs can remain uncommissioned for RGB-only output.

5. DOWNLIGHT SPOTS* Select NONE or ONE from EVERY category (note exceptions below)

NONE Select when specifying linear lampping only

QUANTITY*	OUTPUT	CRI	CCT	BEAM DEGREE
	MIN/S	80	2700K	15 15° spread
	LOW/S	90	3000K	25 25° spread
	TUNE/S#		4000K	40 40° spread
	RGB/S#			

*Contact Light Forms for desired spacing of spots within the fixture
 #For TUNE/S and RGB/S, CRI and CCT do not apply (leave unchecked)

6. INTEGRAL DRIVER* Select ONE

NONDIM	Non-dimming
DALI#	DALI driver, dimming down to 1%
1/10V	1-10V, dimming down to 1%
0/10V	0-10V, dimming down to 0%
DMX^	DMX driver, dimming down to 1%
PHASE	For use with phase-cut triac, IGBT or sine wave dimmer switches

*Driver selection applies to direct, indirect and/or downlight spots. Contact Light Forms if separate driver types for each are required. #DALI is required for use with TUNE/LOW and TUNE/MED; DALI (or DMX) is required for RGBW

^DMX (or DALI) is required for use with RGBW

7. FINISH* Select ONE

WH	White powdercoat (standard)
BLK	Black powdercoat
BZ	Metallic bronze powdercoat
RAL/ ____	Custom RAL# colour powdercoat, ex: RAL/3000

*Contact factory for additional finish options including Interpon, Farrow & Ball and silver and gold plating

See RAL colour options and codes at lightforms.com/RAL

8. POWERFEED COLOUR Select ONE

GP	Grey (standard for suspended, default for other
WP	mountings) White
BP	Black
TP	Transparent
XP	Custom colour (contact Light Forms for options)

9. CANOPY Select ONE

NONE	Select NONE when specifying wall or surface mount
STD	115mm canopy for each separate powerfeed and suspension point (standard)
SMALL	82mm canopy for each separate powerfeed and suspension point
COMBO	115mm combo canopy for locations with both a powerfeed and suspension point

10. OPTIONAL ADD-ONS Select as many as apply

A. EMERGENCY

EM	Integral, 3-hour emergency battery, manual testing
EM/DALI	Integral, 3-hour emergency battery with DALI interface, automatic
EC	testing Emergency circuit

B. SENSOR

PRES	Integral, PIR presence detector
DALI/PRES	Integral, DALI-compatible PIR presence detector
PHOTO	Integral, photocell/daylight detector

C. WIRELESS CONTROL

OLP*	Integral, Osram Lightify Pro wireless control module
------	--

*Must choose DALI option in DRIVER section.

Serpentine 60

SPT60 | Suspended, Surface

LIGHT
FORMS

DIMENSIONS

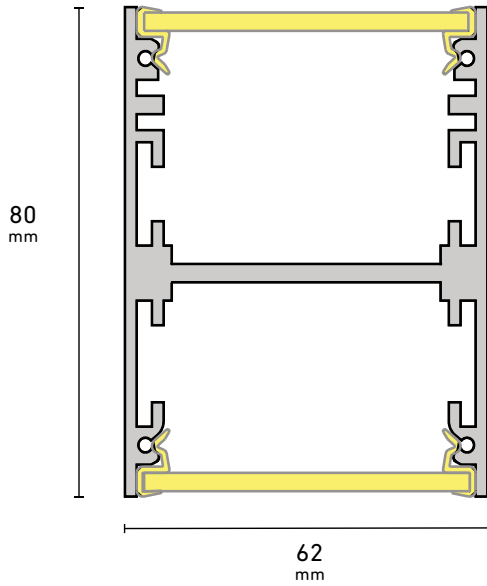

DISTRIBUTION

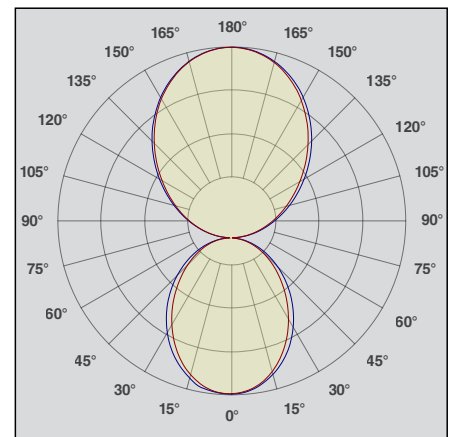
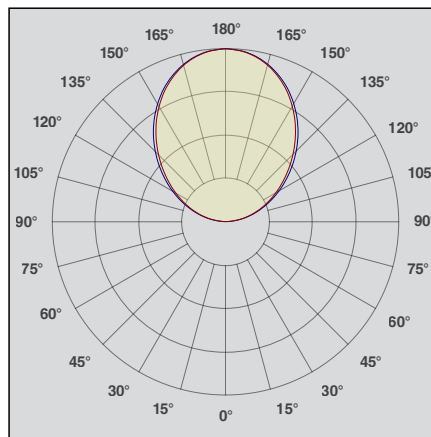
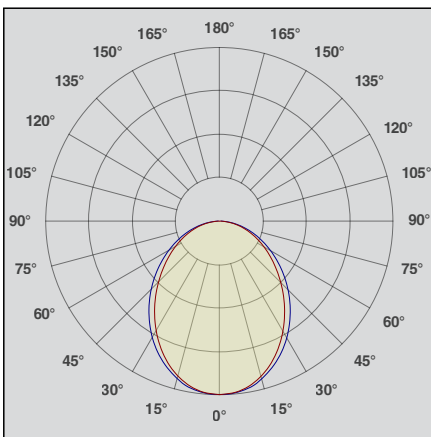

Serpentine 60

SPT60 | Suspended, Surface

**LIGHT
FORMS**

DIRECT LINEAR LAMPING – OPTIONS & PERFORMANCE DATA*

OUTPUT OPTIONS	DELIVERED LUMENS* LM/M	WATTS* W/M	EFFICACY* LM/W	CRI OPTIONS	CCT OPTIONS	LENS OPTIONS
MIN#	1145	11.4	100	80 90	2700K 3000K 4000K 5000K 6500K	DIFF PRS
LOW#	1443	13.8	105			
MED#	2879	25.9	111			
TUNE/LOW#^	Tunable White Low 1177	14	84	80	2700K-6500K	
TUNE/MED#^	Tunable White Medium 1668	22	76	80	2700K-6500K	
RGBW	Colour-Changing RGB+White N/A (entire system) 346 (white only)	19.2 (entire system) 9 (white only)	N/A (entire system) 38 (white only)	N/A (entire system) 80 (white only)	3000K 4000K (white only)	

L80 > 50,000 hours

Luminous flux +/- 5%

**Data provided is for one direct OR one indirect channel. Add and divide output numbers to calculate direct/indirect performance values.*

#Performance data is based on a connected-load photometric test of MED output with 80 CRI at 4000K using a DALI driver and DIFF/F lens. Data values for all other outputs are extrapolations.

^Performance data is extrapolated based on a 4000K setting. Cooler and warmer CCT settings will provide a slight decrease in performance – lower lm/m, higher W/m, and lower lm/W.

LENS OPTIONS

DIFF is a white satin diffuser lens that produces smooth, even light across the lens surface. PRS is a satin prismatic lens covered with microprisms, that produces even light and lower UGR levels.



Diffuse
DIFF



Prismatic
PRS

Serpentine 60

SPT60 | Suspended, Surface

**LIGHT
FORMS**

INDIRECT LINEAR LAMPING – OPTIONS & PERFORMANCE DATA*

OUTPUT OPTIONS	DELIVERED LUMENS* LM/M	WATTS* W/M	EFFICACY* LM/W	CRI OPTIONS	CCT OPTIONS	LENS OPTIONS
MIN#	1259	11.4	87	80 90	2700K 3000K 4000K 5000K 6500K	DIFF PRS
LOW#	1587	13.8	112			
MED#	3165	25.9	104			
TUNE/LOW#^	Tunable White Low 1294 (at 4000K)	14	93	80	2700K-6500K	
TUNE/MED#^	Tunable White Medium 1834 (at 4000K)	22	83	80	2700K-6500K	
RGBW	Colour-Changing RGB+White N/A (entire system) 380 (white only)	19.2 (entire system) 9 (white only)	N/A (entire system) 42 (white only)	N/A (entire system) 80 (white only)	3000K 4000K (white only)	

L80 > 50,000 hours

Luminous flux +/- 5%

**Data provided is for the indirect channel. Add and divide output numbers as necessary from both direct and indirect charts to calculate direct/indirect performance values.*

#Performance data is based on a connected-load photometric test of MED output with 80 CRI at 4000K using a DALI driver and DIFF lens. Data values for all other outputs are extrapolations.

^Performance data is extrapolated based on a 4000K setting. Cooler and warmer CCT settings will provide a slight decrease in performance – lower lm/m, higher W/m, and lower lm/W.

LENS OPTIONS

DIFF is a white satin diffuser lens that produces smooth, even light across the lens surface. PRS is a satin prismatic lens covered with microprisms, that produces even light and lower UGR levels.



Diffuse
DIFF



Prismatic
PRS

Serpentine 60

SPT60 | Suspended, Surface

**LIGHT
FORMS**

DOWNLIGHT SPOTS – OPTIONS & PERFORMANCE DATA*

OUTPUT OPTIONS	DELIVERED LUMENS LM/M	WATTS W/M	EFFICACY LM/W	CRI OPTIONS	CCT OPTIONS	BEAM DEGREE OPTIONS
MIN/S#	1101	11.6	95	80 90	2700K 3000K 4000K	15 25 40
LOW/S#	1430	15.9	90			
TUNE/S	Contact Light Forms for Options & Details					
RGB/S	Contact Light Forms for Options & Details					

L80 > 50,000 hours
Luminous flux +/- 5%

**Performance calculations are based on connected-load photometric tests with 80 CRI at 4000K and 40° beam spread.*

SPOTS



Minimum
MIN/S



Low
LOW/S

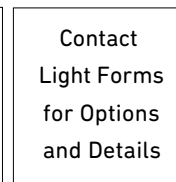

Tunable White
TUNE/S

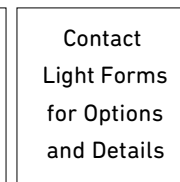

RGB
RGB/S

Contact
Light Forms
for Options
and Details

Contact
Light Forms
for Options
and Details

Serpentine 60

SPT60 | Suspended, Surface

LIGHT
FORMS

SPECIFICATION DETAILS

HOUSING

100% recyclable, extruded architectural grade aluminium with minimum 2mm thickness.

FINISH OPTIONS

Standard finish is textured White powdercoat. Black, Bronze or custom RAL powdercoat options are also specifiable. Contact Light Forms for other finish options (Interpon, Farrow & Ball and silver and gold plating).

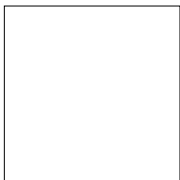

White
WH



Black
BLK

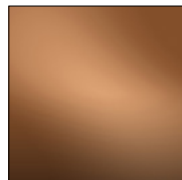

Bronze
BZ

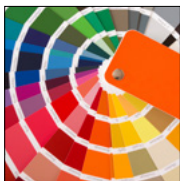

Custom RAL
RAL

View all RAL
colour options at:
[https://
lightforms.com/
RAL](https://lightforms.com/RAL)

SUSPENSION MOUNT CANOPY OPTIONS

Standard (STD) comprises separate 115 mm powerfeed canopy and cable bullet at powerfeed locations. SMALL comprises separate 85 mm powerfeed canopy and cable bullet at powerfeed locations. COMBO comprises combined 115mm canopy (canopy and cable bullet) at powerfeed locations. All options include cable bullets for non-powerfeed locations.

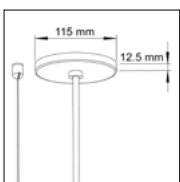

Standard
STD

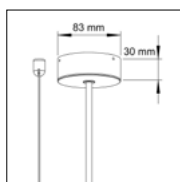

Small
SMALL

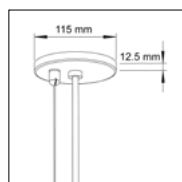

Combo
COMBO

INTEGRAL SENSORS

Optional, presence (PRES), DALI-compatible PIR presence (DALI/PRES) and daylight harvesting (PHOTO) sensors available. Contact Light Forms for further information.

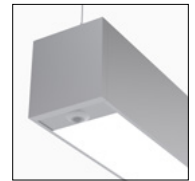

INTEGRAL DOWNLIGHTS

Optional, aimable accent downlight spots deliver up to 1430 lumens with beam spreads from 15 to 40°. Limitations apply. See Downlight Spots chart for further information.



WEIGHT

Approximately 2380 grams per linear metre. Weight will increase with the addition of integral downlights, sensors, and emergency batteries and may vary further depending on mounting and other options.

OPERATING TEMPERATURE

Luminaire MUST be installed and operated ONLY in dry or damp environments where the ambient temperature ranges from -20°C to 50°C. Luminaire operation in environments outside this temperature range voids the warranty AND may damage the product or adversely impact lamp life, lumen output and colour consistency.

WARRANTY

5-year limited warranty. Details: lightforms.com/warranty

MANUFACTURING & CERTIFICATION

Products are manufactured in and comply with the health, safety and environmental protection standards of the respective region in which they are sold as indicated below.



Europe



Asia



Greater India
+ Middle East

Serpentine 60

SPT60 | Suspended, Surface

LIGHT
FORMS

PHOTOS

